

PM4100APD Application Note: Energy Meter Evaluation Module



sames

PM4100APD

FEATURES

- Compatible with **SA4102A / SA2002E / SA2002H / SA2002P / SA2002D / SA2102D**. All devices are PDIP20, except for the SA2002P which is PDIP16.
- Connection of external sensing elements, mains and power supply by means of screw terminals.
- Operation from either single +5V supply or dual rail supply (20mA).
- Direction and pulse output indication by means of on-board LEDs.
- Current sensing via shunt or CT (on-board termination resistor).
- Counter and stepper counter connections by means of screw terminals.
- On-board precision calibration either by analog trimpot or digital Eeprom.
- Direct connection to micro-controller.
- Optically isolated output for connection to test equipment.
- Easy accessible test pins

INTRODUCTION

The PM4100AD evaluation module is designed to demonstrate the functionality of the following devices SA4102A, SA2002E, SA2002H, SA2002P, SA2002D and SA2102D. The module is easily configured and setup for the various devices by means of on-board jumpers. The setup of the module is simplified with the help of the accompanying software that illustrates the jumper positions for each device.

(PULSE), while a stepper motor counter or impulse counter can be connected to the screw terminals provided. A second LED (DIR) is used to indicate the energy direction.

This application note should be used in conjunction with each device's specific datasheet for the individual device specifications and characteristics.

The measured energy is displayed on an on-board LED

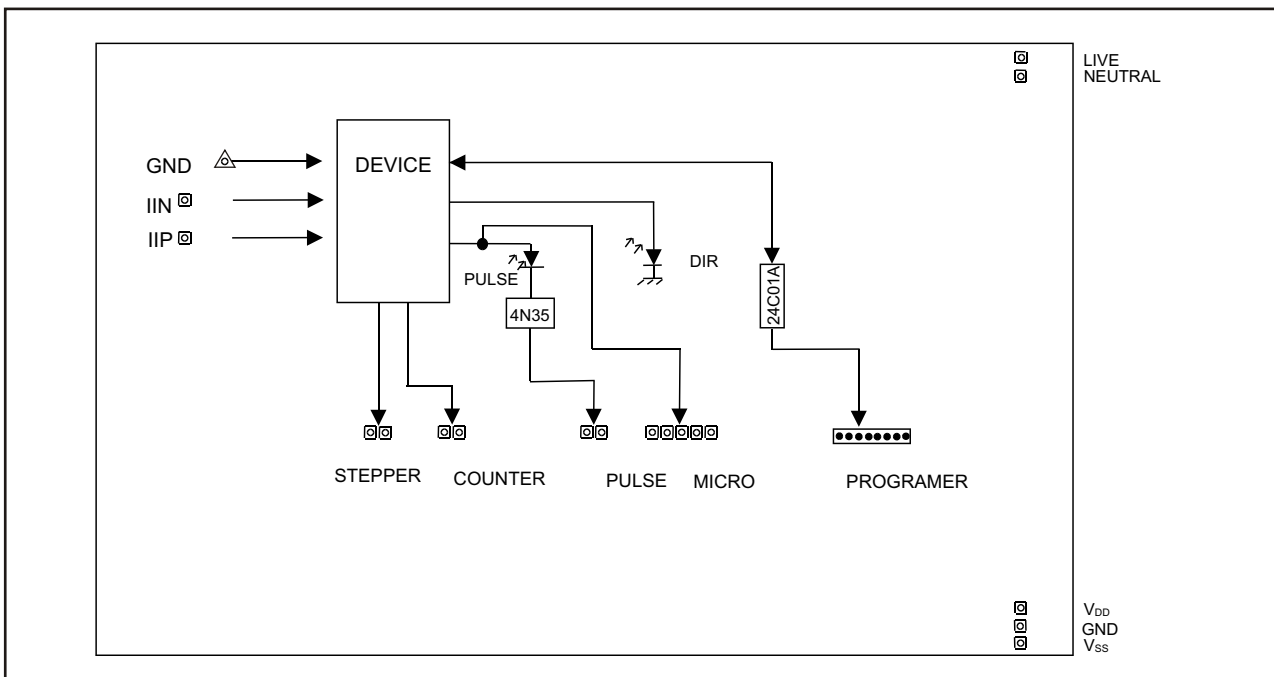

Figure 1: Functional Diagram



ANALOG INPUT

The most important external components for any SAMES integrated circuit are the current and voltage sense resistors, as well as the bias setting resistors. These resistors must be of the same type as specified in the parts list to ensure that temperature effects and noise susceptibility is minimized.

VOLTAGE INPUT IVP

The voltage input is driven with a current of $14\mu A_{RMS}$ ($11\mu A_{RMS}$ to SA4102A) at the nominal rated mains voltage. Please note that this input will saturate with currents bigger than approximately $17\mu A_{RMS}$, which translates into a 20% overdrive capability. This also ensures that the device will not saturate with a 10% variance in mains voltage. The main voltage is divided down via a resistor network (see Figure 2) to $14V_{RMS}$. This voltage is fed to a $1M$ resistor (R8) to realize the $14\mu A_{RMS}$.

The resistor values are chosen in such a way that shorting jumper J2 leads to half the voltage on the voltage divider output. This feature makes the module compatible for both 220V and 110V supply networks.

Ignoring jumper J2 results in the following equations:

$$RA = R5 + R6 + R7 + R10$$
$$RB = R8 \parallel (R9 + 0.5P1)$$

The center position of P1 is used in the equation to ensure that calibration can be done by adjusting P1 to be higher or lower.

Combining the two equations gives:

$$(RA + RB)/220V = RB/14V$$

Values for resistors R9 = 12k , P1 = 20k and R8 = 1M is chosen.

Substituting the values result in:

$$RB = 26.29k$$
$$RA = RB \times (220V/14V - 1)$$
$$RA = 386.84k$$

Choosing standard resistor values for R5, R6, R7, R10 and keeping in mind that J2 must half the output voltage leads to the following values:

$$R5 = R7 = 82k$$
$$R6 = R10 = 100k$$

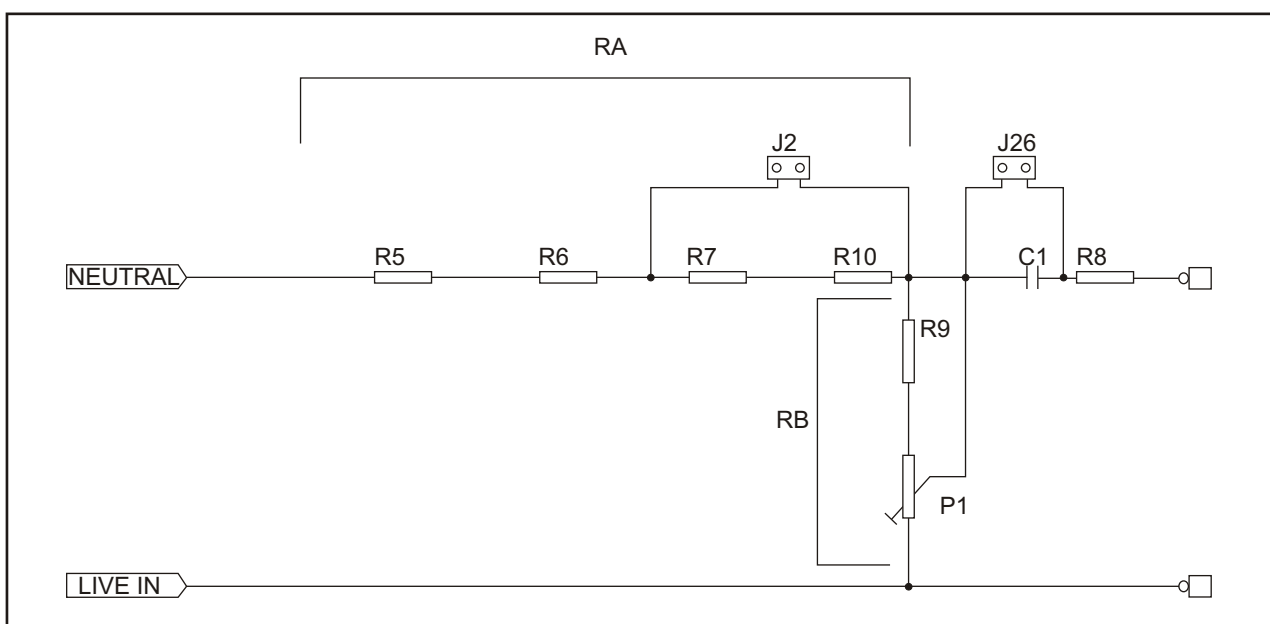

Figure 2: Voltage divider circuit

CURRENT SENSE INPUT

Resistors R2 and R3 (figure 3 and figure 4) define the current level into the current sense inputs of the device. The PM4100APD module can be configured to use any type of shunt or CT, but to ensure proper current sensing it is advisable to use a shunt or CT that will give a voltage drop of at least 20mV at maximum supply current. The resistor values are calculated for an input of $16\mu A_{RMS}$ on the current sense inputs at rated conditions. The design equation is as follows:

$$R2 = R3 = (I_L / 16\mu A) \times R_{SH} / 2 \quad \text{SHUNT Sensing}$$

I_L = Line current
 R_{SH} = Shunt value

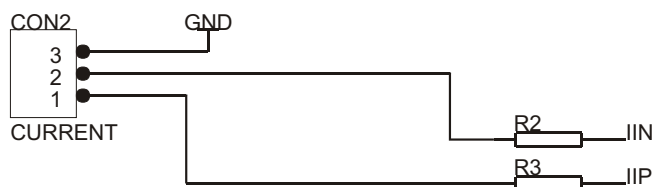

Figure 3: Current sensing using a shunt

SENSING METHOD (CT OR SHUNT)

Provision is made for the use of either a Current Transformer (CT) or a Shunt on the application module. For use with a CT, the terminating resistor (R1) and phase compensation capacitor (C1), as well as jumper (J1) must be inserted. The jumper references one side of the CT to ground for sensing. When using a CT the current sensing resistors (R2 and R3) must be inserted according to the equation stated below.

$$R2 = R3 = (I_L / 2500 / 16\mu A) \times R_1 / 2 \quad \text{CT Sensing}$$

I_L = Line current
 1:2500 = CT ratio

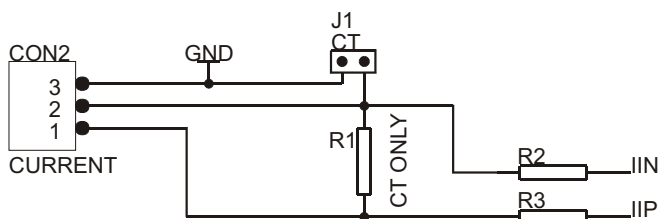

Figure 4: Current sensing using a CT

The capacitor C1 is inserted to compensate for the phase shift caused by the current transformer. The following equation shows how to calculate the capacitor value for a phase shift of 0.18 degrees.

$$C = 1 / (2\pi \times \text{Mains frequency} \times R8 \times \tan(\text{Phase shift angle}))$$

$$C = 1 / (2\pi \times 50 \times 1M \times \tan(0.18 \text{ degrees}))$$

$$C = 1.013\mu F$$

CTs with a low phase is recommended.

REFERENCE VOLTAGE

The on chip reference current is determined from a biasing resistor R4 connected between pin 3 of the device and V_{SS} . This is 47k for the SA2102D and SA4102A, and 24k for the rest of the devices compatible with this module.

ANALOG GROUND (GND)

The GND pin of the device is connected to the analog ground plane, which is halfway between V_{DD} and V_{SS} .

SETUP OF THE PM4100APD AS AN ENERGY/POWER EVALUATION BOARD

The PM4100APD evaluation module comes with several jumper selections, which allows the user to setup the module to work for any of the devices mentioned. Tables 2 to 8 describe the various jumper options. These tables should be used in conjunction with figure 9, as well as the accompanying software on disk (PM4100.exe) which will make it easier to locate the jumper in question.

External connectors

The PM4100APD module connects directly to live and neutral by means of a screw terminal (SCK1), and the current sensing element is connected to CON2 as is shown in figures 5 and 6. Connection diagram for CON3 and CON6 is shown in figures 7 and 8.

Programming the SA2002P must be done via an external programmer/opto-isolator that connects to CON 3. There is such a module available on request from SAMES, or a module can be build as per information supplied in Figure 7.

Table 1 lists all the connectors available on the module.

Name	Description
SK1	Mains Connection
CON1	Power Supply
CON2	Sensing element connector
CON3	Programmer (SA2002P)
CON4	Stepper Motor Counter
CON5	Impulse Counter
CON6	Micro Controller
CON7	Opto-isolated Output Pulses

Table 1: External connector descriptions

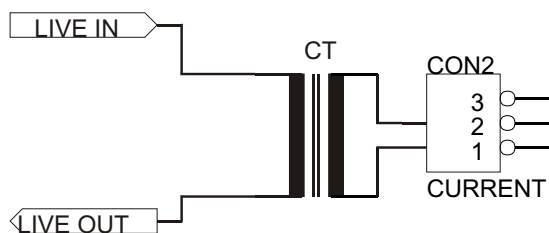

Figure 5: Current connection diagram for CT

Jumper Selection

The jumpers listed in table 2 is device independent and must be setup according to the users needs.

Name	Option
J1	This jumper must be inserted when measurement is done using a CT, and left open when using a shunt.
J2	This jumper must be inserted when working from a 110V supply system, and left open when a 220V supply is used.
J24	This jumper must be closed for regular use
J26	Insert this jumper when using a shunt, and leave open when using a CT.

Table 2: Device independent jumpers

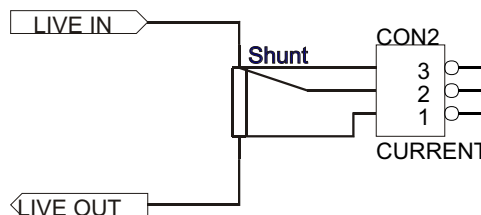

Figure 6: Current connection diagram for Shunt

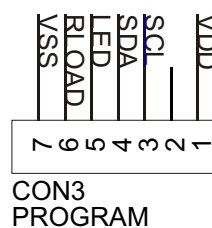

Figure 7: SA2002P Programming Connector

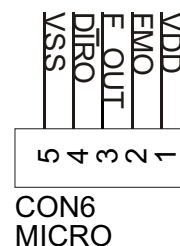

Figure 8: Micro Controller Connector

**SA2002P**

Name	State
J4	B
J5	B
J6	A
J7	B
J8	B
J9	B
J10	B
J11	A
J12	A
J15	A
J22	CLOSED
J25	A

Table 3: Jumper options for SA2002P

SA2002H (J6, J13, J15 to be used with Micro-controller)

Name	State
J6	B
J11	B
J12	B
J13	B
J14	A
J15	A
J25	A

Table 4: Jumper options for SA2002H

SA2002E

Name	State
J11	B
J14	A
J25	A

Table 5: Jumper options for SA2002E

SA2002D

Name	State
J7	A
J8	A
J9	A
J10	A: Setting to A and J20 to + enables the FAST output mode. Leaving J10 and J20 open disables FAST mode and enables standard mode.
J11	B
J12	B
J13	A
J17, J18, J19	Rated conditions select (J17 for R0, J18 for R1, J19 for R2). Please refer to the SA2002D datasheet for further information. For Fast mode, any combination except all to +. For different normal mode settings, refer to the SA2002D datasheet. Note: On module + = V _{DD} and - = V _{SS}
J20	"+" : FAST mode enabled. "-" or OPEN: Standard mode enabled. Also see J10.
J23	"-"
J25	A

Bi-Directional Energy Measurement

J4	A
J5	B

Uni-Directional Energy Measurement

Forward	
J3	+
J4	A
J5	A
Reverse	
J3	-
J4	A
J5	A

Table 6: Jumper options for SA2002D



SA2102D

Name	State
J7	A
J8	A
J9	A
J10	A: Setting to A and J20 to + enables the FAST output mode. Leaving J10 and J20 open disables FAST mode and enables standard mode.
J11	B
J12	B
J13	A
J14, J15	B. Connect if a stepper motor or counter is to be connected.
J17, J18, J19	Rated conditions select (J17 for R0, J18 for R1, J19 for R2). Please refer to the SA2102D datasheet for further information. For Fast mode, any combination except all to +. For different normal mode settings, refer to the SA2102D datasheet. Note: On module + = V _{DD} and - = V _{SS}
J20	“+” : FAST mode enabled. “-” or OPEN: Standard mode enabled. Also see J10.
J21	CLOSED: Inserting the jumper enables the pulse stability circuitry. OPEN: Leaving it open disables the pulse stability circuitry.
J23	“-”
J25	A

Bi-Directional Energy Measurement

J4	A
J5	B

Uni-Directional Energy Measurement

Forward	
J3	+
J4	A
J5	A
Reverse	
J3	-
J4	A
J5	A

Table 7: Jumper options for SA2102D

SA4102A

Name	State
J7	A
J8	A
J9	A
J10	A
J11	B
J12	B
J13	A
J14, J15	Set to B to enable stepper motor or counter connectors (CON 4 and CON 5)
J17, J18, J19, J21,	Rated conditions select (J17 for R0, J18 for R1, J19 for R2, J21 for R3). Please refer to the SA4102 datasheet for further information.
J20	Fms (see datasheet). Leave J20 open for fast pulse output.
J23	Filter output select. Set to + for Averaging filter. Set to - for Filtered instantaneous output.
J25	A

Bi-Directional Energy Measurement

J4	A
J5	B

Uni-Directional Energy Measurement

Forward	
J3	+
J4	A
J5	A
Reverse	
J3	-
J4	A
J5	A

Table 8: Jumper options for SA4102A



Module Calibration

The output frequency can be adjusted and calibrated by means of the variable resistor P1 connected in the voltage divider as shown in figure 2.

PCB Design Considerations

There are numerous PCB design aspects to consider when designing a power/energy meter, but only a few crucial aspects will be discussed here.

The sense resistors on the current input, R2 and R3 must be located as close to the SAMES device input pins as possible. This also holds true for the 1M resistor (R8), and the biasing resistor R4. Also note that the supply bypass capacitors C2, C3 and C4 (insert C5 and C6 for the SA2002P) must be positioned as close as possible to the supply pins of the device, and connected to a solid ground plane.

It is advisable to keep the ground plane surrounding the device clear of noise that may influence the sensing signals.

The module is protected from high transients on the main voltage input by means of a Metal Oxide Varistor. These MOVs will clamp any high transients with a sufficiently long rise time to neutral, hence protecting the PCB. When designing a meter, a MOV of type S20 should be used, as the S10 type titled here will not withstand high surge tests.

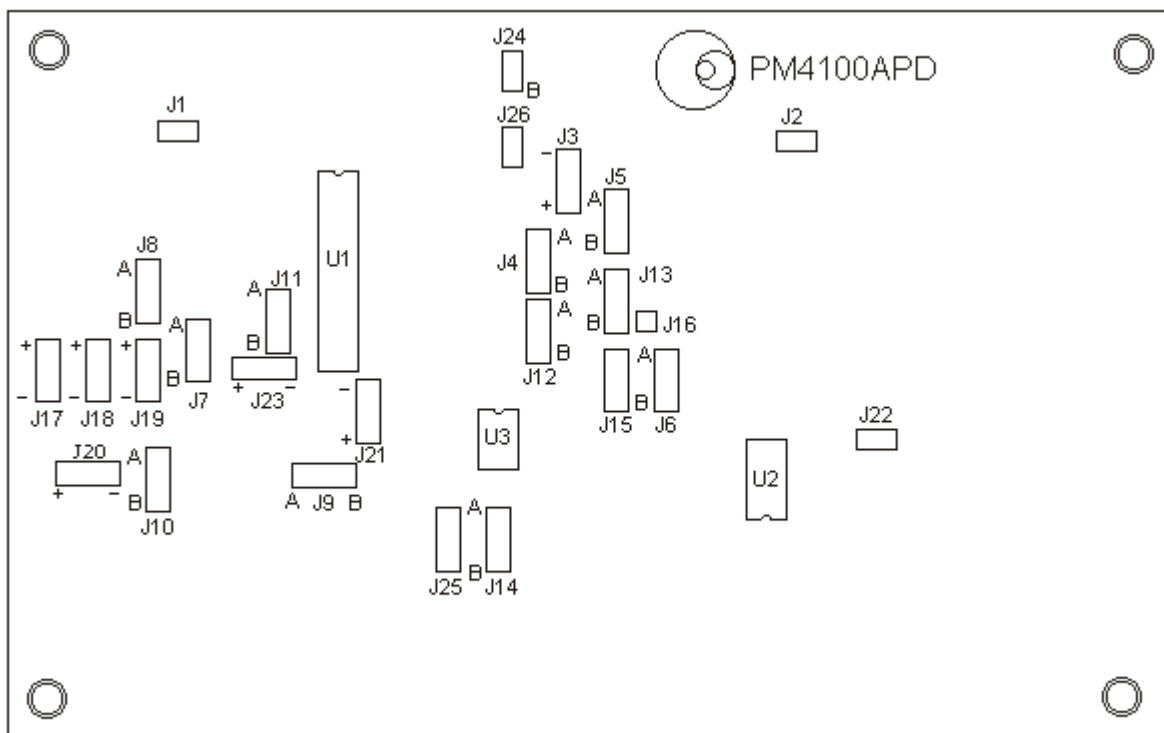

Figure 9: Jumper positions

**EVALUATION BOARD COMPONENT LIST**

Designator	Part Type	Description
C1	Non-Polar	2.54mm, PITCH, NON-POLAR 16V, See page 3 for calculation of value
C10	10uF	2.54mm, PITCH, TANTALUM. At least 10V
C2	220nF	5.08mm, CERAMIC
C3	220nF	5.08mm, CERAMIC
C4	1uF	5.08mm, CERAMIC
C5	220nF	0805 SMD CERAMIC, should be fitted for SA2002P
C6	220nF	0805 SMD CERAMIC, should be fitted for SA2002P
C7	100nF	5.08mm PITCH, CERAMIC
C8	100nF	5.08mm PITCH, CERAMIC
C9	10uF	2.54mm PITCH, TANTALUM. At least 10V
CON1	CONNECTOR	5.08mm PITCH, 3-WAY SCREW TERMINAL
CON2	CONNECTOR	5.08mm PITCH, 3-WAY SCREW TERMINAL
CON3	CONNECTOR	7 Single Inline Pins
CON4	CONNECTOR	5.08mm PITCH, 2-WAY SCREW TERMINAL
CON5	CONNECTOR	5.08mm PITCH, 2-WAY SCREW TERMINAL
CON6	CONNECTOR	5.08mm PITCH, 5-WAY SCREW TERMINAL
CON7	CONNECTOR	5.08mm PITCH, 2-WAY SCREW TERMINAL
J1	INLINE PINS	2 Single Inline Pins
J10	INLINE PINS	3 Single Inline Pins
J11	INLINE PINS	3 Single Inline Pins
J12	INLINE PINS	3 Single Inline Pins
J13	INLINE PINS	3 Single Inline Pins
J14	INLINE PINS	3 Single Inline Pins
J15	INLINE PINS	3 Single Inline Pins
J16	INLINE PINS	1 Single Inline Pins
J17	INLINE PINS	3 Single Inline Pins
J18	INLINE PINS	3 Single Inline Pins
J19	INLINE PINS	3 Single Inline Pins
J2	INLINE PINS	2 Single Inline Pins
J20	INLINE PINS	3 Single Inline Pins
J21	INLINE PINS	3 Single Inline Pins
J22	INLINE PINS	2 Single Inline Pins
J23	INLINE PINS	3 Single Inline Pins
J24	INLINE PINS	2 Single Inline Pins
J25	INLINE PINS	3 Single Inline Pins
J26	INLINE PINS	2 Single Inline Pins
J3	INLINE PINS	3 Single Inline Pins
J4	INLINE PINS	3 Single Inline Pins
J5	INLINE PINS	3 Single Inline Pins
J6	INLINE PINS	3 Single Inline Pins



EVALUATION BOARD COMPONENT LIST (Continued)

Designator	Part Type	Description
J7	INLINE PINS	3 Single Inline Pins
J8	INLINE PINS	3 Single Inline Pins
J9	INLINE PINS	3 Single Inline Pins
L1	LED	3mm, GREEN
L2	LED	3mm, RED
P1	20k	Multiturn, TopAdjust
R1	CT ONLY	1/4 WATT, 1% METAL FILM RESISTOR. See CT Datasheet
R10	100k	1/4 WATT, 1% METAL FILM RESISTOR
R11	4k7	1/4 WATT, 1% METAL FILM RESISTOR
R12	1k6	1/4 WATT, 1% METAL FILM RESISTOR
R13	680R	1/4 WATT, 1% METAL FILM RESISTOR
R14	680R	1/4 WATT, 1% METAL FILM RESISTOR
R15	1k	0805 SMD 1%
R16	1k	0805 SMD 1%
R2	RES (To be calculated)	1/4 WATT, 1% METAL FILM RESISTOR. See page 3
R3	RES (To be calculated)	1/4 WATT, 1% METAL FILM RESISTOR. See page 3
R4	RES 24k Standard. 47k for SA2102D / SA4102 A	1/4 WATT, 1% METAL FILM RESISTOR (As default this position is left open, fit Resistor according to device used)
R5	82k	1/4 WATT, 1% METAL FILM RESISTOR
R6	100k	1/4 WATT, 1% METAL FILM RESISTOR
R7	82k	1/4 WATT, 1% METAL FILM RESISTOR
R8	1M	1/4 WATT, 1% METAL FILM RESISTOR
R9	12k	1/4 WATT, 1% METAL FILM RESISTOR
S1	PB	Miniature Pushbutton, Push to make
SK1	MAINS	5.08 PITCH, 3-WAY SCREW TERMINAL
TP1	VDD	Testpin
TP2	VSS	Testpin
TP3	GND	Testpin
TP4	14V	Testpin
U1	DEVICE	20 PIN DIL, Tulip Type Socket
U2		8 PIN DIL, Tulip Type Socket
U2	24C01A	1k 128x8 CMOS EEPROM - MICROCHIP
U3		6 PIN DIL, Tulip Type Socket
U3	4N35	4N35, 6 PIN DIP
Z1	MOV	S10/K320; Use type S20 when designing a meter

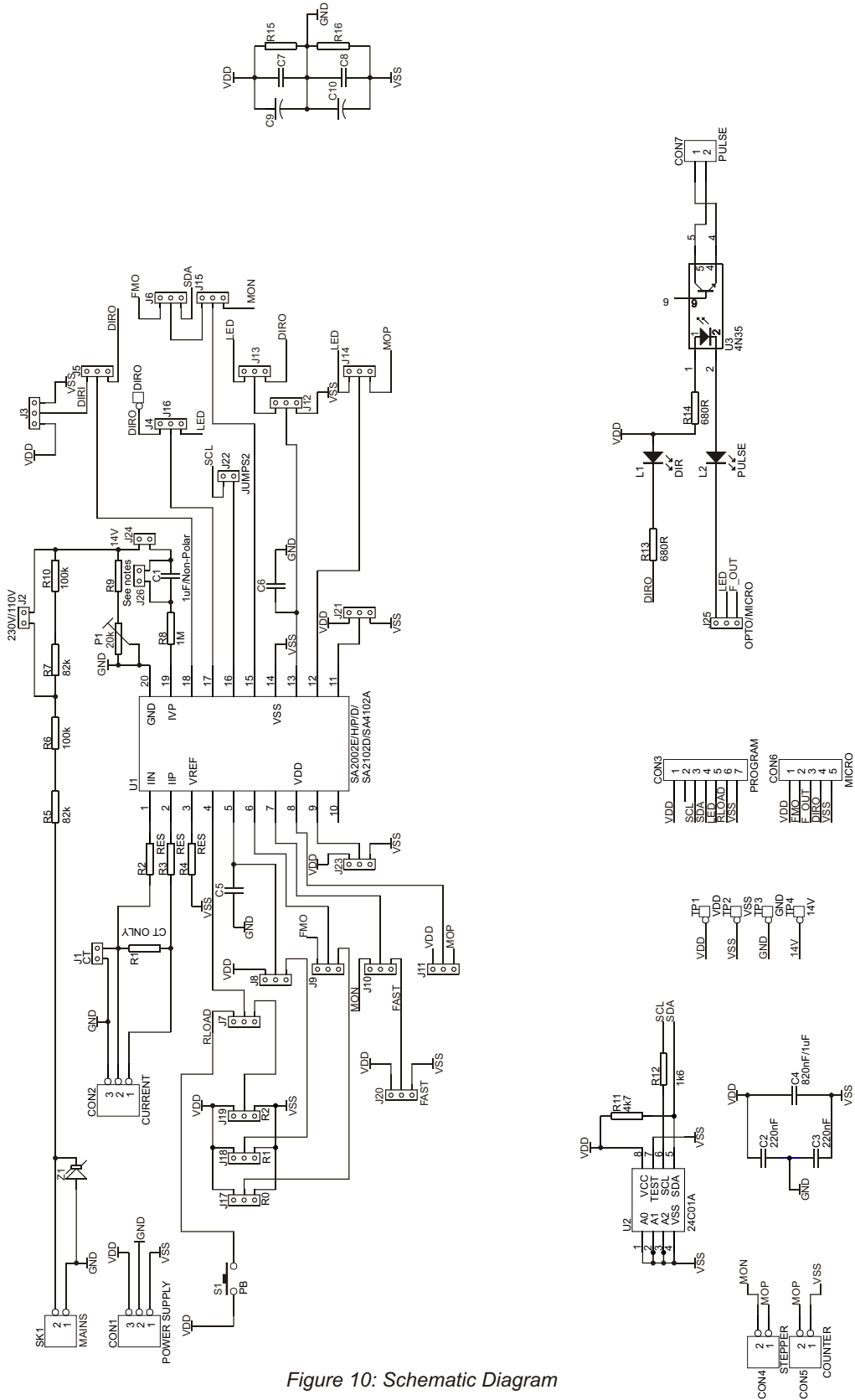

Figure 10: Schematic Diagram

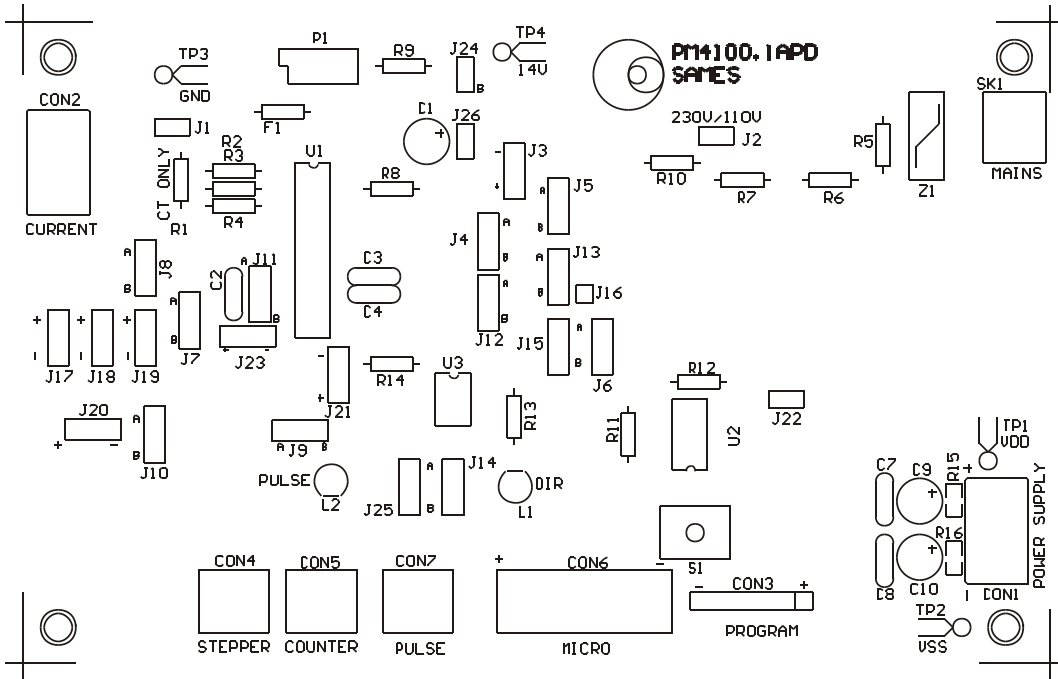

Figure 11: Top Silkscreen

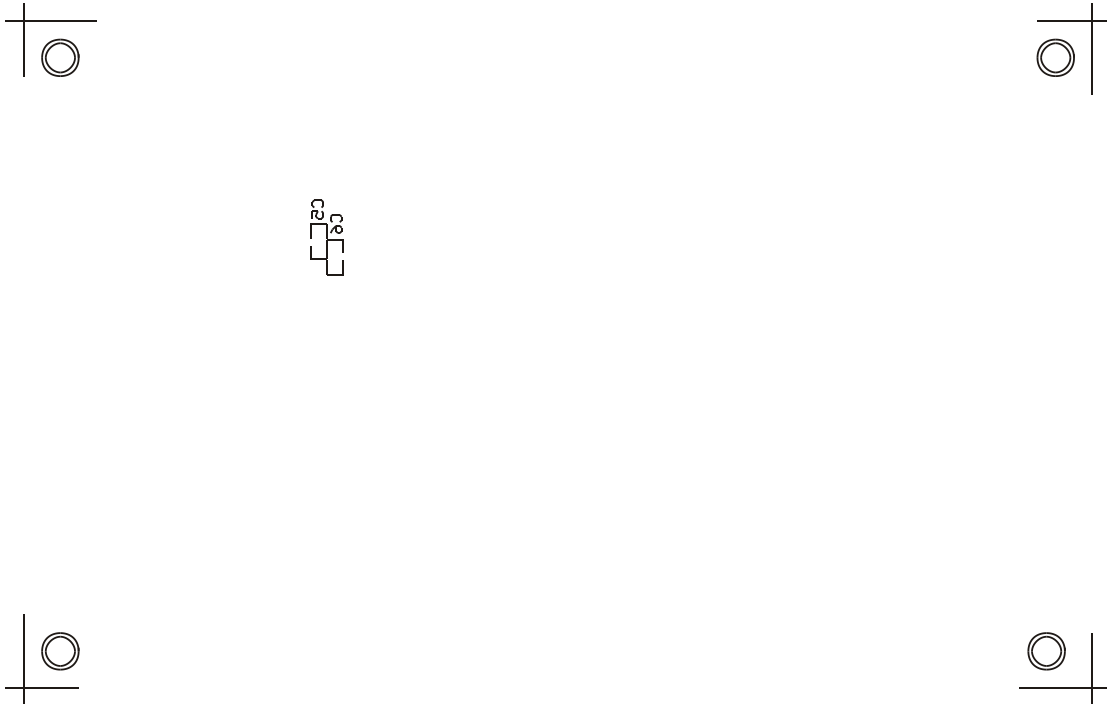

Figure 12: Bottom Silkscreen

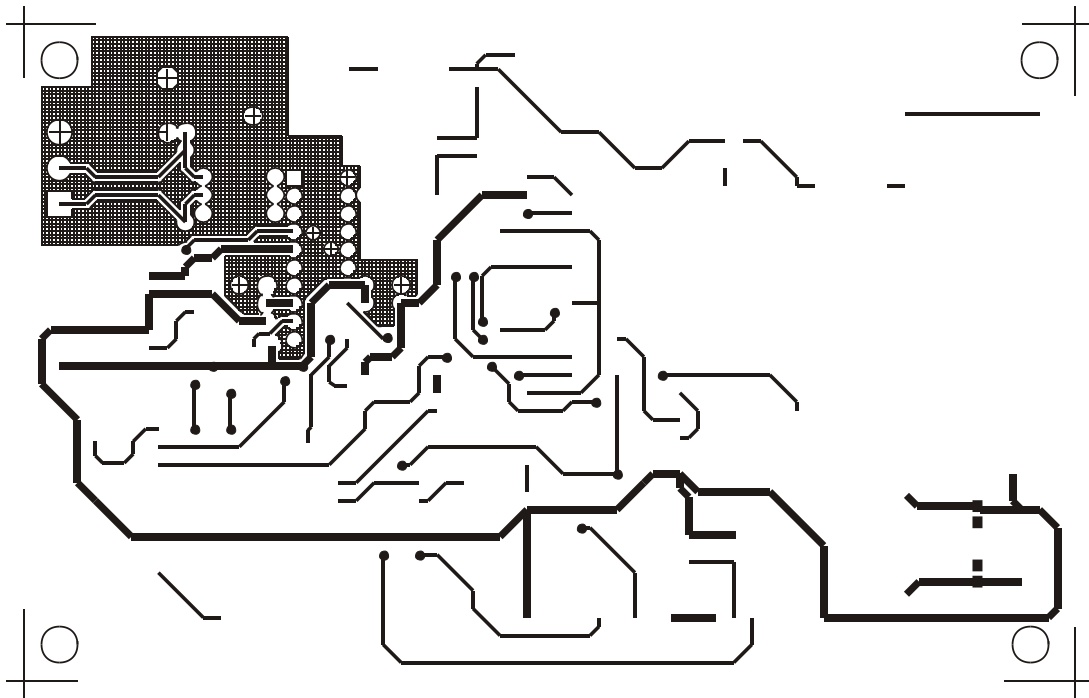

Figure 13: Top PCB Layout

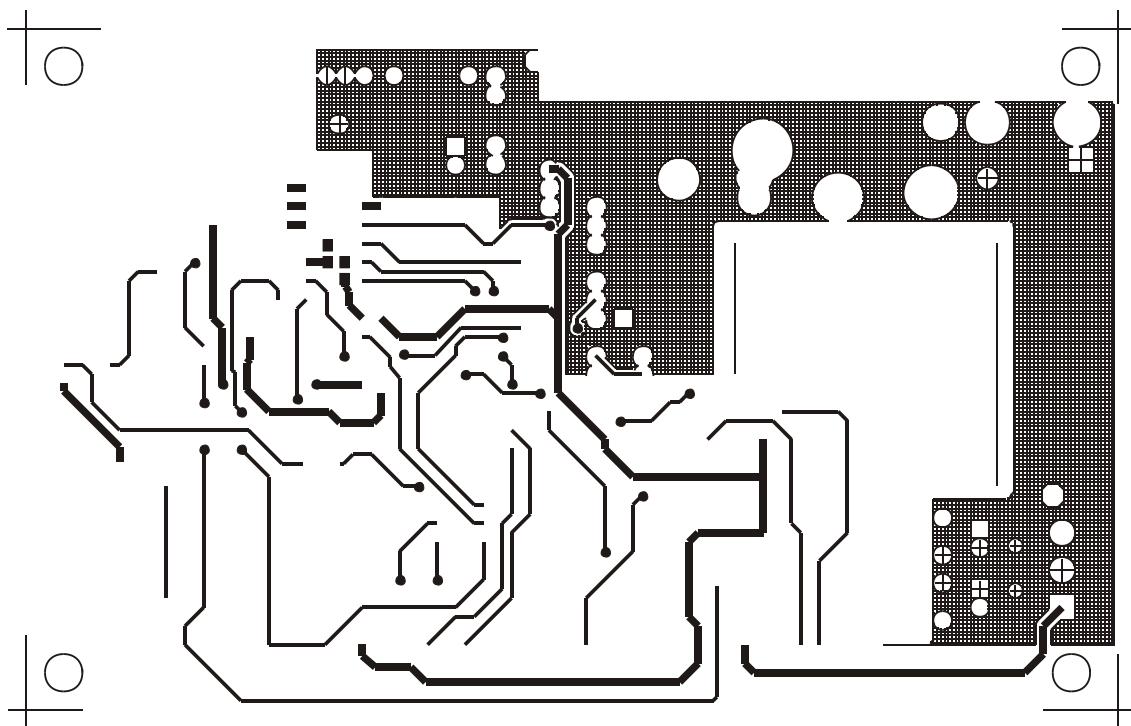

Figure 14: Bottom PCB Layout



sames

PM4100APD

NOTES:



sames

PM4100APD

DISCLAIMER:

The information contained in this document is confidential and proprietary to South African Micro-Electronic Systems (Pty) Ltd ("SAMES") and may not be copied or disclosed to a third party, in whole or in part, without the express written consent of SAMES. The information contained herein is current as of the date of publication; however, delivery of this document shall not under any circumstances create any implication that the information contained herein is correct as of any time subsequent to such date. SAMES does not undertake to inform any recipient of this document of any changes in the information contained herein, and SAMES expressly reserves the right to make changes in such information, without notification, even if such changes would render information contained herein inaccurate or incomplete. SAMES makes no representation or warranty that any circuit designed by reference to the information contained herein, will function without errors and as intended by the designer.

Any sales or technical questions may be posted to our e-mail address below:
energy@sames.co.za

For the latest updates on datasheets, please visit our web site:
<http://www.sames.co.za>.

SOUTH AFRICAN MICRO-ELECTRONIC SYSTEMS (PTY) LTD

Tel: (012) 333-6021
Tel: Int +27 12 333-6021
Fax: (012) 333-8071
Fax: Int +27 12 333-8071

**P O BOX 15888
LYNN EAST
0039
REPUBLIC OF SOUTH AFRICA**

**33 ELAND STREET
KOEDOESPOORT INDUSTRIAL AREA
PRETORIA
REPUBLIC OF SOUTH AFRICA**